

Features

- 12" (305 mm) bar.
- Provides minimum 300 lb load capacity.
- Coordinates with transitional-style KOHLER® faucets and showering components.

Material

- Premium metal construction for durability and reliability.
- KOHLER finishes resist corrosion and tarnishing.



Codes/Standards





None Applicable

KOHLER® One-Year Limited Warranty

See website for detailed warranty information.

Available Colors/Finishes

Color tiles intended for reference only.

Color	Code	Description
	CP	Polished Chrome
	BN	Vibrant® Brushed Nickel
	2BZ	Oil-Rubbed Bronze
	2MB	Vibrant® Brushed Moderne Brass

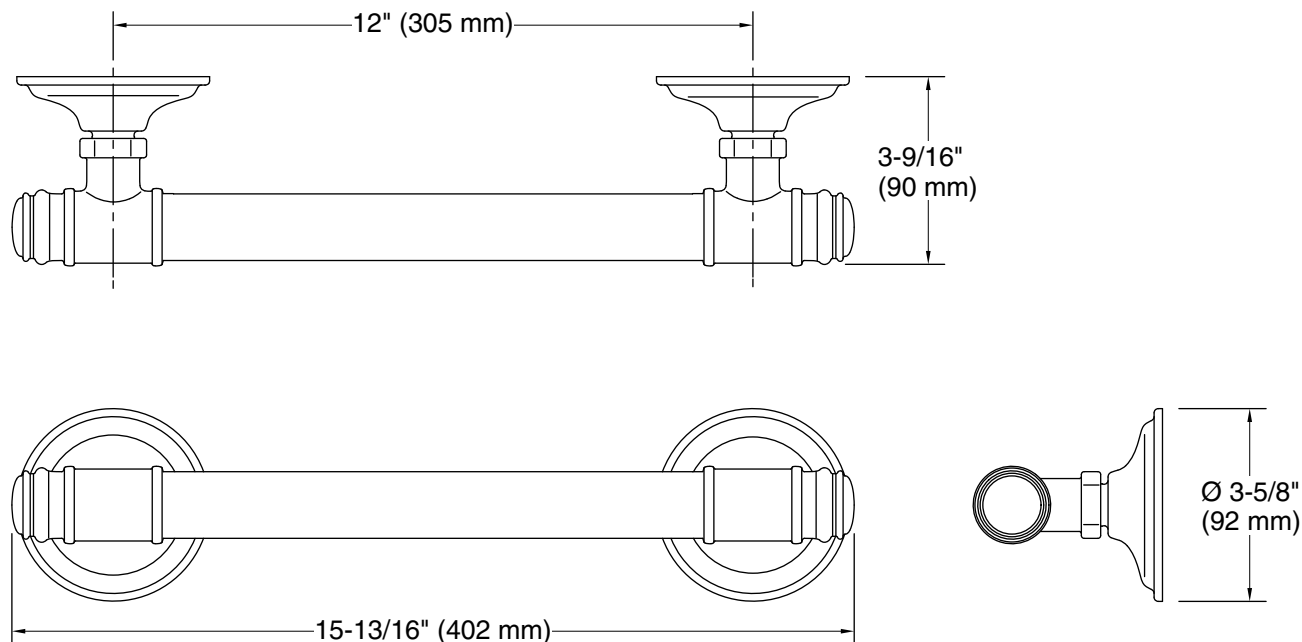

Technical Information

All product dimensions are nominal.

Installation Type: Wall-mount

Material: Zinc, Stainless Steel

Notes

Measure your actual product for roughing-in details.

WARNING: Risk of personal injury. The wall plates on the grab bar must be mounted to a brace between the wall studs. This will ensure that the weight of the user is adequately supported.